

YASKAWA

GA500

Industrial AC Microdrive



The GA500 Industrial AC Microdrive is engineered to help you easily handle nearly any application. Sustainability, flexibility and ease of use are all designed into the drive, helping you make complicated tasks simple.

Offering intuitive interaction and world-class quality, the GA500 is the drive you can count on for constant, high quality performance.

Make your day easier and leave more time for other tasks by trusting the GA500 from Yaskawa.



Balancing Power to Perfection

The Yaskawa GA500 industrial AC Microdrive builds on our foundation of creating drives based on extensive industry application experience, limitless flexibility and high quality, helping you achieve the perfect balance of power within your operations.



Time & Cost Savings

- Operates any motor on any network
- DriveWorksEZ® improves customization by eliminating a PLC and simplified wiring
- Integrated braking transistor
- Integrated EMC filter (optional)
- Integrated 24 VDC power supply supports use of external sensors without extra power supply

Easy Installation & System Integration

- Embedded functional safety (STO: SIL3, PLe)
- Embedded Modbus RTU
- Up to 5 drives with 1 network option card
- Side-by-side mounting
- Bottom cable entries, cage clamp terminals
- DIN rail mounting adapter
- DriveWizard® Mobile app for easy and convenient setup
- Optional LCD operator

Easy to Use & Maintain

- Reduce setup time with an intuitive keypad and setup wizards
- Simple parameter structure
- Maintain network communications during loss of main input power
- Access to main circuit w/o removing cover

Easy Machine Design

- Wide power and voltage range
- Coated PCBs for use in harsh environments
- Speed search
- Stall prevention and torque limit
- Meets global standards (UL, cUL, CE, TUV, RCM)
- Supports all major networks

effortless integration
MAKING safe intuitive
easy
COMPLICATED
rugged powerful
SIMPLE sustainable
quality flexible

240 VAC, Single-Phase: 1/6 – 5 HP
240 VAC, Three-Phase: 1/6 – 30 HP
480 VAC, Three-Phase: 1/2 – 40 HP

Quick & Easy

Whether you are installing, wiring, programming, or troubleshooting, the GA500 has features that help simplify the task for you.



Setup Wizard

Reduce setup time to minutes using the setup wizard. Even without any drive parameter knowledge, the step-by-step wizard will guide you and get you up and running.

Display

Easy-to-read LED display.

Keypad

Multi-directional buttons to help you intuitively navigate through drive menus and parameters. Tactile feel of the buttons lets you know when you've pressed a button.

Parameter Backup / Copy

Removable keypad allows you to backup and copy parameters to other drives.

24 VDC Power Input for Controller

Simplify your wiring and keep your control system operating even during standby or power outage.



USB Port

Easily connect your PC or mobile device to program the drive with or without power.

LED Status Ring

You can determine the drive status with a quick glance at the LED status ring and know the GA500 is ready and operating.

Finger Safe Terminals

Easily access terminals to make the wiring process faster and easier. No need to remove the cover.

Power Range

- 240 VAC, Single-Phase: 1/6 – 5 HP
- 240 VAC, Three-Phase: 1/6 – 30 HP
- 480 VAC, Three-Phase: 1/2 – 40 HP

No Power? No Problem!

The GA500 can be programmed without any power supply connected, even while the drive is still in the box. Simply plug into one of your PC's USB ports or any USB on-the-go device, start programming and enjoy the ease of commissioning.



Enhance your experience with the optional LCD keypad.

- Advanced keypad navigation
- High-resolution display
- Automatic backup function
- Copy function (4 parameter sets)
- Real-time clock
- Micro SD storage for data logging (up to 32 GB)
- Optional Bluetooth® version

Bluetooth® is a registered trademark of Bluetooth SIG, Inc. USA.

Effortless Network Integration

Connect to your network in less than 60 seconds. GA500 drives support all the major industrial communications and connection topologies (ring, star, line, etc.) to adapt to various factory automation networks. Reduce wiring when connecting to an upper level controller or PLC through available built-in protocols or dedicated communication options.

Configurations

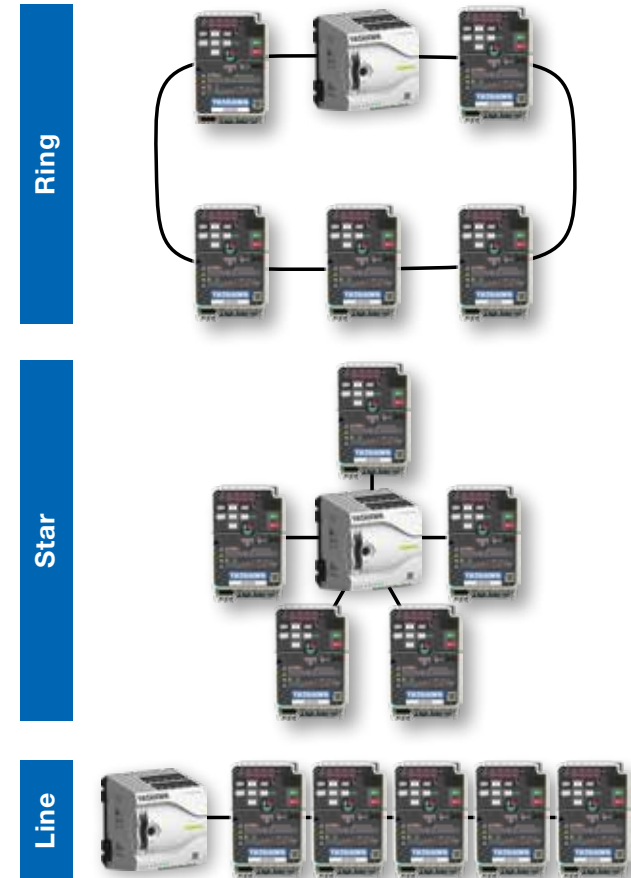

Cost Effective Integration

Reduce the number of option cards up to 80%. Only a single communication option card is required to network up to 5 drives via the RS-485 terminals.

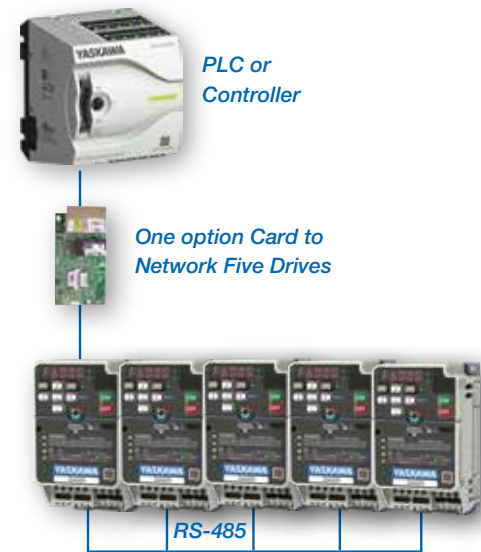

Embedded +24 VDC Input Access

Network communication can be maintained during loss of main input power utilizing the +24 VDC input. An external +24 VDC supply also allows you the ability to program the drive without main power.



One for All

The GA500 precisely controls induction, permanent magnet, and synchronous reluctance motors providing versatility to run a variety of applications with just one drive.

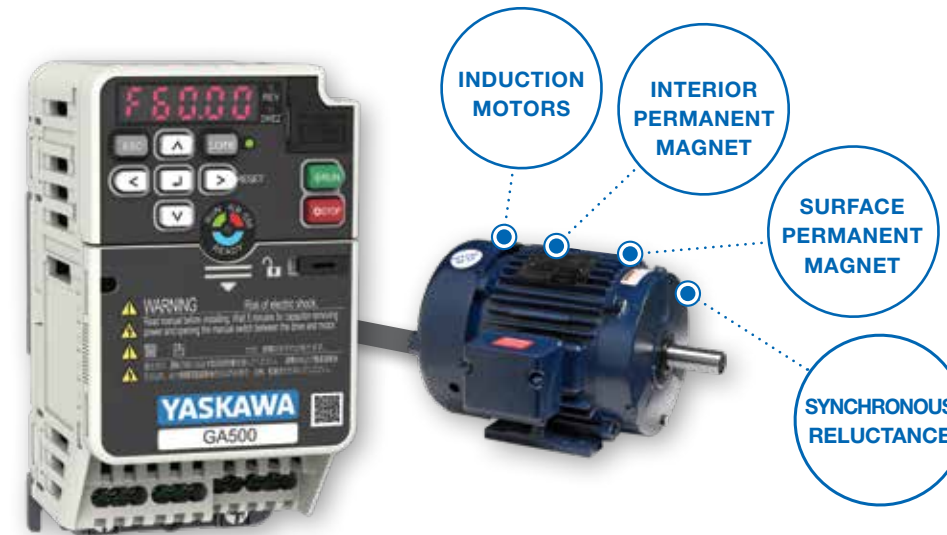

Motor Control Benefits/Features:

One Drive for Various Applications

- 590 Hz output frequency (optional: up to 1000 Hz)
- Open loop zero speed and torque control of permanent magnet motors

Energy Savings

- Automatic energy efficiency optimizer with GA500 energy saving functions

Automatic Energy Efficiency Optimizer

Energy usage is automatically optimized with the unique energy savings functions of the GA500. These functions minimize energy consumption through varying load and speed ranges, achieving power optimization for energy cost reduction. Maximize your energy usage by optimizing your motor torque per amp.

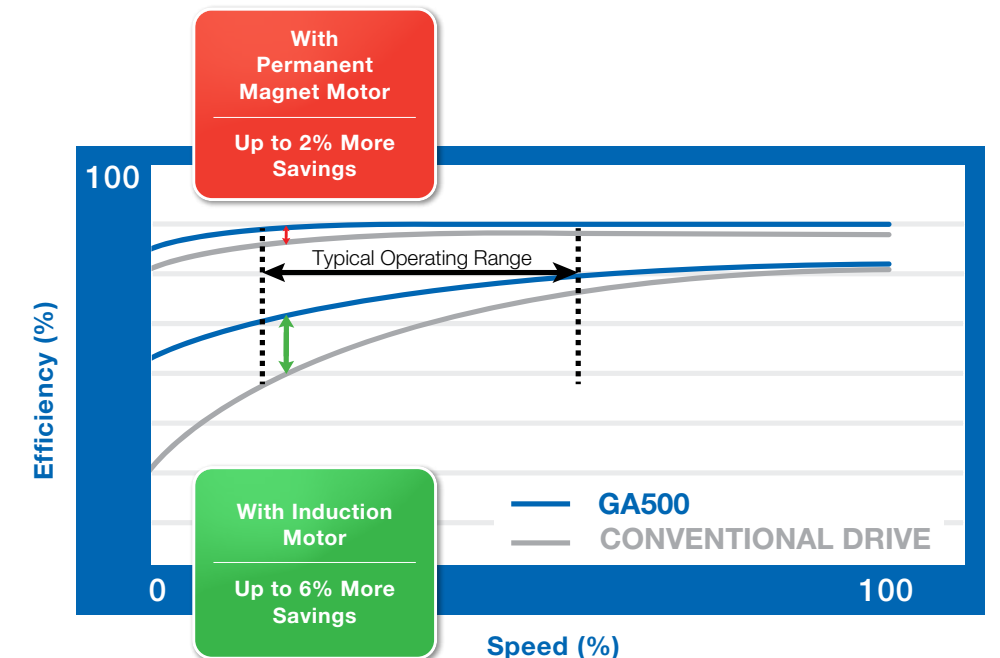

Play it Safe

Integrated Functional Safety

With the built-in dual channel STO (safe torque off, SIL3/PLe), the GA500 provides the right tools for easy machine integration of emergency stop functions, even when elevated levels of risk reduction are required.

TÜV Certified

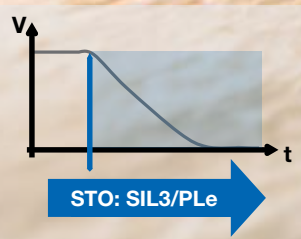

Rugged

Designed for 10 years of maintenance-free operation, the GA500 is built tough to withstand harsh and demanding conditions.

Wide Ambient Temperature Range

GA500 drives can be safely operated in ambient temperatures ranging from -10°C up to 60°C. In environments with conditions up to 50°C, no derating is necessary.

Coated Circuit Board Protection

Coated PCBs as standard protect the electronics from dust or humidity, while ensuring reliable operation even in harsh environments (IEC 60723-3-3, 3C2, 3S2).



Flexible Installation Solutions



The flexible package design of the GA500 enables reliable operation under a variety of environmental conditions. Regardless of whether you put the drive in a control cabinet, on a wall, in a clean environment, or in a harsh one.

Built-In EMC Filter

The GA500 is available both with and without an embedded EMC filter.



Without EMC Filter



Built-in EMC Filter

Side-by-Side Mounting

The GA500 can be mounted side-by-side with bottom entry wiring to reduce cabinet size.

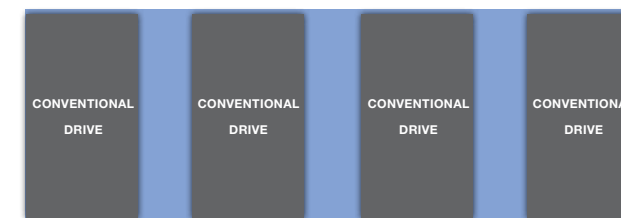

Reduced Cabinet Size
Up to 45%

Easy External Back Heatsink Mounting

With an optional ring kit, the GA500 offers easy installation for mounting the heatsink outside the cabinet to reduce cabinet size and cooling requirements.



DIN Rail Mounting

GA500 drives up to 7.5 HP can be simply snapped onto a DIN rail using an optional attachment. This saves valuable time during installation.



UL Type 1 Kit

For installations that require UL Type 1, the GA500 can be simply converted with a mechanical kit.



UL Type 1 Kit

Powerful Tools

If you are looking to keep a backup copy of your GA500's parameter set or need to customize the drive's functionality to match your application, the GA500 has the software tools to help.

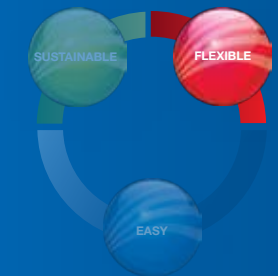

Software Tools

DriveWizard® Industrial

- Manage your parameters online or offline
- Create configurations offline, then later connect and download them to the GA500
- Connect via USB, and interface with the GA500 even without main power
- Monitor using a dashboard of dynamic variables
- Create reports for exporting and emailing



DriveWorksEZ®

- Create simple, custom logic and eliminate an external controller
- Drag-n-drop graphical interface
- 400+ function blocks
- Up to 100 connections
- Offline simulation mode for testing without the risk of an application malfunction
- Protection of intellectual property with locked projects

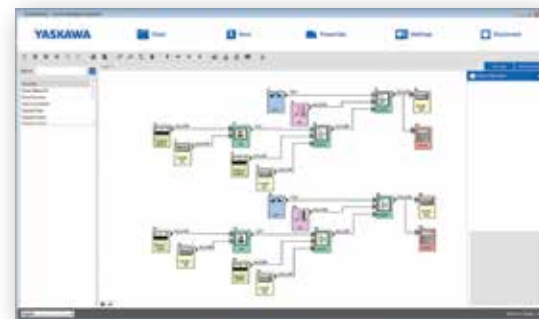

DriveWizard® and DriveWorksEZ® are registered trademarks of Yaskawa America, Inc.

DriveWizard® Mobile App

The DriveWizard® Mobile app turns your smartphone or tablet into an interface for your GA500 drive. All information for parameter setup and troubleshooting are in your pocket – anytime, anywhere. Scanning the drive QR code provides easy access to drive information and status. DriveWizard Mobile also provides:

- Intuitive parameter editing with help and search function
- Custom parameter and monitor lists
- Parameter backup/verify with or without main power applied to the drive
- Yaskawa Drive Cloud™ Service
- Export to DriveWizard® Industrial



Yaskawa Manuals App

You will have all drive information available, without carrying heavy manuals.

- Resize text for improved readability
- Search feature to find the information you need
- Access to the most up-to-date technical information (when connected online)
- Download manuals for use when an online connection isn't available.

Yaskawa Drive Cloud™ Service

- Product registration with QR code
- Complimentary storage for parameter backups, relevant files, and notes
- Accessible anywhere



Parameter Compatibility

DriveWizard® makes it simple to transition from previous generation drives to the GA500.

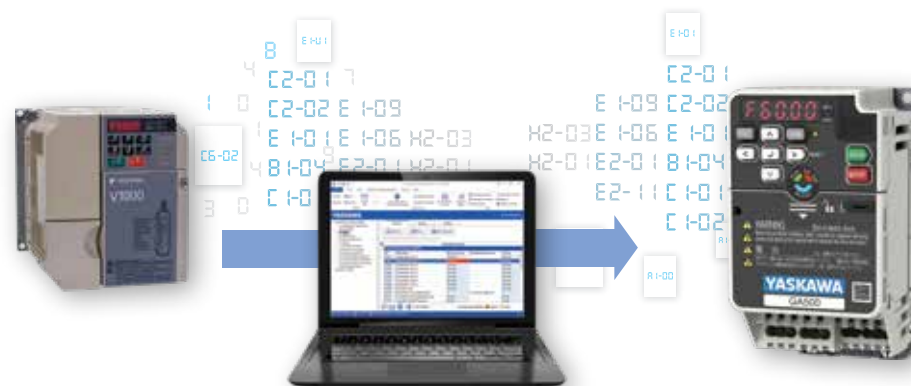

Yaskawa Drive Cloud™

The Yaskawa Drive Cloud service provides an easy and safe way to keep track of all of your drive data.



Making Your Day Easier



From the moment you wake in the morning to the moment your head hits the pillow at night, you have a lot going on in your mind.

At Yaskawa, we consider it our job to provide you the highest quality, most reliable variable frequency drive product and service – so every day in your life can be just a little bit easier.

We make the complicated simple!



Conveyor

Reduce mechanical stress on your machine by gently ramping up to speed.



Pump

Maintain constant water pressure with the PID functionality of a drive.



Fan

Control air flow and save energy by being able to easily control the speed of your fan.



Mixer

High torque to be able to mix any type of material, precise speed control to make sure that it gets done right.



Machining Center

Power and precision to create the parts that you need.



Catalog Code Designation

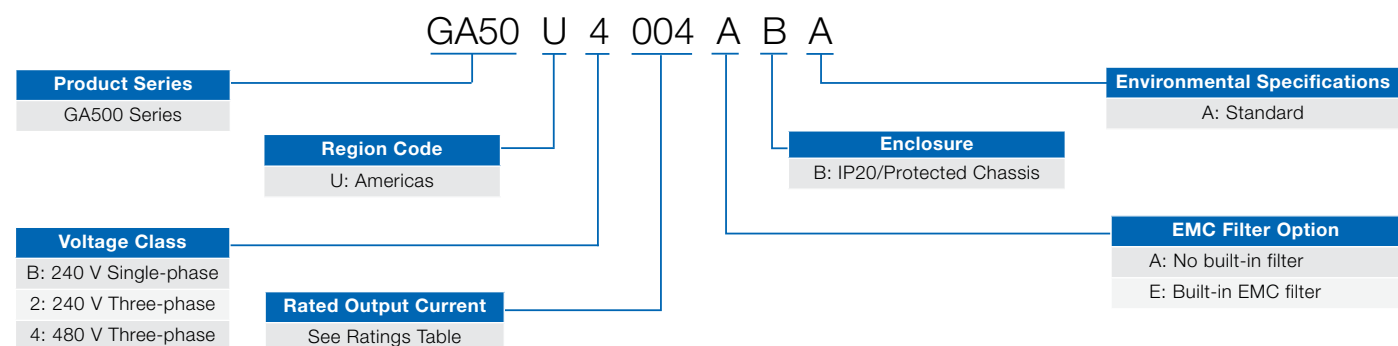

Ratings

Power Output (HP)		240 V Models									480 V Models			
Normal Duty (ND)	Heavy Duty (HD)	Single-Phase			Three-Phase			Three-Phase			Catalog Code	Output Amps		Frame
		Catalog Code	ND	HD	Frame	Catalog Code	ND	HD	Frame	ND		HD		
1/6	1/6	GA50UB001ABA	1.2	0.8	1.1	GA50U2001ABA	1.2	0.8	1.1					
1/4	1/4	GA50UB002ABA	1.9	1.6	1.1	GA50U2002ABA	1.9	1.6	1.1					
1/2	1/2									GA50U4001ABA	1.2	1.2	2.1	
3/4	1/2	GA50UB004ABA	3.5	3	1.3	GA50U2004ABA	3.5	3	1.2					
1	3/4									GA50U4002ABA	2.1	1.8	2.2	
1.5	1	GA50UB006ABA	6	5	2.4	GA50U2006ABA	6	5	1.4					
2	2									GA50U4004ABA	4.1	3.4	2.4	
3	2	GA50UB010ABA	9.6	8	2.5	GA50U2010ABA	9.6	8	2.3					
3	3	GA50UB012ABA	12.2	11	3.2					GA50U4005ABA	5.4	4.8	2.5	
4	3					GA50U2012ABM	12.2	11	2.4	GA50U4007ABA	7.1	5.6	2.5	
5	4									GA50U4009ABA	8.9	7.3	2.5	
N/A	5	GA50UB018ABA	N/A	17.6	4									
7.5	5					GA50U2021ABA	21	17.6	3.1	GA50U4012ABA	11.9	9.2	3.1	
10	7.5					GA50U2030ABA	30	25	5					
10	10									GA50U4018ABA	17.5	14.8	5	
15	10					GA50U2042ABA	42	33	5	GA50U4023ABA	23.4	18	5	
20	15					GA50U2056ABA	56	47	6	GA50U4031ABA	31	24	6	
25	20					GA50U2070ABA	70	60	7	GA50U4038ABA	38	31	6	
30	25					GA50U2082ABA	82	75	7	GA50U4044ABA	44	39	8	
40	30									GA50U4060ABA	60	45	8	

Approximate Dimensions

Frame Size	1.1	1.2	1.3	1.4	2.1	2.2	2.3	2.4	2.5	3.1	3.2	4	5	6	7	8
Height	5.04 (128)												10.24 (260)	11.81 (300)	13.78 (350)	
Width	2.68 (68)			4.25 (108)			5.51 (140)		6.69 (170)	5.51 (140)	7.09 (180)	8.66 (220)	7.48 (190)			
Depth	2.99 (76)	4.25 (108)	4.65 (118)	5.04 (128)	3.19 (81)	3.90 (99)	5.08 (129)	5.41 (137)	6.06 (154)	5.63 (143)	6.42 (163)	7.09 (180)	5.51 (140)	5.63 (143)	7.36 (187)	8.03 (204)

Dimensions shown in inches (mm).
Information on this page represents IP20/Protected Chassis type enclosures without the built-in EMC filter.
For other enclosure types and enclosure adapters, please visit [yaskawa.com](https://www.yaskawa.com).

Operating Environment	
Ambient Temperature	-10 to +50°C (IP20/Protected Chassis), -10 to +40°C (IP20/UL Type 1), up to +60°C with derating
Storage Temperature	-40 to +70°C (short-term temperature during transportation)
Humidity	95% RH or less (non-condensing)
Altitude	Up to 1000 m without derating, up to 4000 m with derating
Shock	10 to 20 Hz: 9.8 m/s ² 20 to 55 Hz: 5.9 m/s ²
Protection Design	IP20/Protected Chassis (Standard), IP20/UL Type 1 kit (Optional)
Mounting	Side-by-side, DIN rail, external heatsink
Conformal Coating (PCBs)	IEC 60721-3-3, Class 3C2 (chemical gases), Class 3S2 (solid particles)
Standards	CE, UL, cUL, KC, RCM, EAC, RoHS
Functional Safety	IEC/EN 61800-5-2: STO, IEC/EN 61508: SIL3, EN ISO 13849-1: PL _E
Power Ratings	
Overload Capacity	110%/1 min. (Normal Duty) or 150%/1 min. (Heavy Duty)
Rated Voltage	200 to 240 V, -15 to +10% 380 to 480 V, -15 to +10%
Capacity Range	240 V, Single-phase: 1/6 to 5 HP (0.1 to 3.7 kW) 240 V, Three-Phase: 1/6 to 30 HP (0.1 to 22 kW) 480 V, Three-Phase: 1/4 to 40 HP (0.2 to 30 kW)
Input Frequency	50/60 Hz, +/-5%
Output Voltage Accuracy	+/-5%
Output Frequency	0 to 590 Hz (special software for up to 1000 Hz)
Control Method	V/f, Open Loop (IM/PM), Advanced Open Loop (PM), EZ Open Loop Vector
Motor Control	Induction Motor (IM), Interior or Surface Permanent Magnet Motor (IPM/SPM), Synchronous Reluctance Motor (SynRM)
Standard I/O	(7) multi-function digital inputs (24 VDC) (2) multi-function analog inputs (0 +/-10 VDC, 4-20 mA) (1) multi-function pulse input (2) Safe Torque Off (STO) inputs (1) fault relay output (form C) (2) multi-function photocoupler outputs (1) multi-function analog output (0 - 10 VDC, 4-20 mA) (1) multi-function pulse output (1) RS-485 (Modbus RTU)
Additional Functions	Integrated PID controller with sleep function, automatic load distribution for multiple axes (droop control), automatic main power loss ride through, speed search function for smooth start of coasting motors, braking with over-magnetization for fast stop without braking resistors, energy-saving function, automatic restart after failure, overvoltage suppression, virtual input/output custom configuration, application presets, vibration suppression
Options	
Communications (Requires Additional Mounting Kit)	CANopen®, CC-Link, DeviceNet™, EtherCAT®, Ethernet/IP™, Ethernet/IP Dual Port, MECHATROLINK-II, MECHATROLINK-III, Modbus/TCP, Modbus/TCP dual port, PROFIBUS-DP®, PROFINET®, LONWORKS
Additional Options	Bluetooth keypad, LCD keypad, Attachment for external heatsink, External EMC filters, AC reactors, DC chokes, Network communications adapter, LCD keypad attachment, braking resistors



To learn more about the GA500 and see how it can make your day-to-day life easier, please visit <https://www.yaskawa.com/ga500>.



Yaskawa is the leading global manufacturer of low and medium voltage variable frequency drives, servo systems, machine controllers and industrial robots. Our standard products, as well as tailor-made solutions, are well known and have a high reputation for outstanding quality and reliability.